

# 1/16-DIN SIMPLIFIED CONTROLLER CONCISE PRODUCT MANUAL (59224-5)

## OPERATING MODE

**Note:** Set all Range/Alarm and Setting Up parameters as desired before starting normal operations.

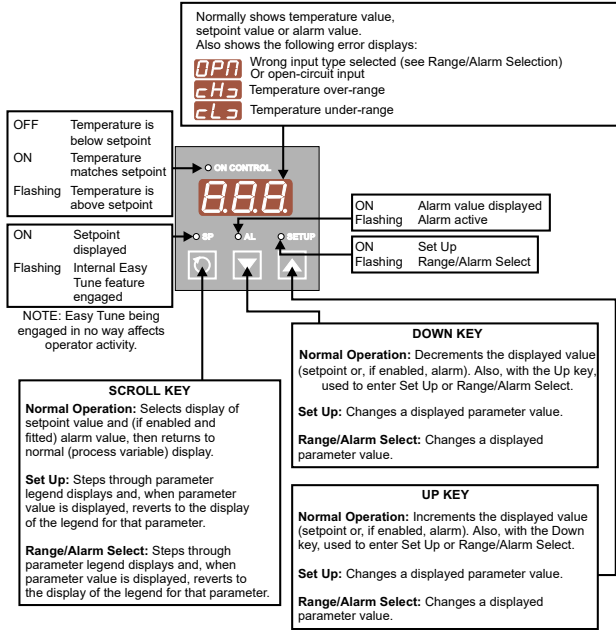

## Front Panel

### Adjusting Setpoint and Alarm Value

The normal display shows temperature value. Use the Scroll key to select display of setpoint value and (if enabled - see **SETTING UP**) alarm value. If adjustment of these parameters is enabled (see **SETTING UP**), use the Up/Down keys to adjust the displayed parameter value. Use the Scroll key to restore the temperature value display.

## SETTING UP

**NOTE:** Set all Range/Alarm parameters as desired before starting Setup operations.

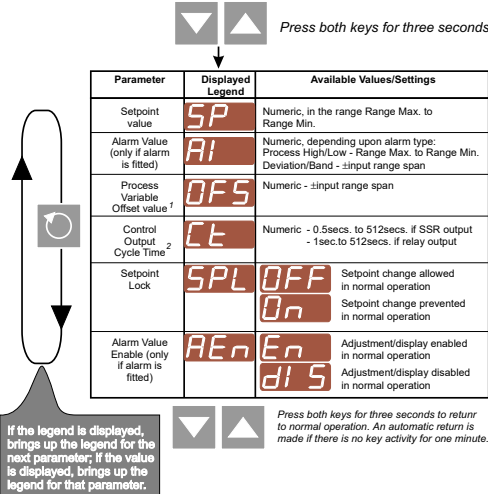

## NOTES ON SETTING UP

1. The Process Variable (PV) Offset modifies the actual process variable (PV) value as follows:

$$\text{Modified PV} = \text{Actual PV} + \text{PV Offset}$$

The modified PV value is used for all PV-dependent functions (control, display, alarm). Choose this value with care; it is, in effect, a calibration adjustment. **There is no indication when this parameter is in effect (i.e. has been set to a non-zero value).**

2. The cycle time required is dependent upon the process being controlled and the type of output being used. For a relay output, the cycle time should be as large as possible (whilst remaining compatible with the process control requirements) to maximise relay life. For an SSR output, the cycle time may have a lower value.

## INSTALLATION

**CAUTION:** Installation should only be performed by personnel who are technically-competent and authorised to do so. Local Regulations regarding electrical installation & safety must be observed.

**WARNING:** This product can expose you to chemicals including arsenic, which is known to the State of California to cause cancer. For more information go to [www.P65Warnings.ca.gov](http://www.P65Warnings.ca.gov)

### Panel-Mounting

The mounting panel must be rigid and may be up to 6.0mm (0.25 inches) thick. The cut-outs required for the Controllers are shown on the right. Controllers may be mounted side-by-side in a multiple installation for which the cut-out width (for n Controllers) is (48n - 4)mm or (1.89n - 0.16) inches.

The panel-mounting procedure is shown below:

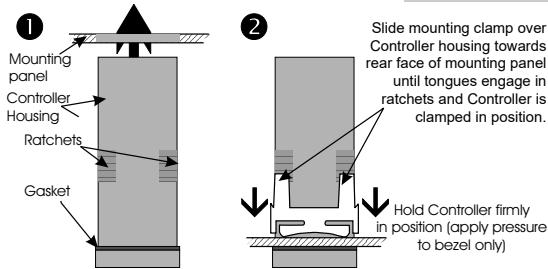

### Rear Terminal Connections

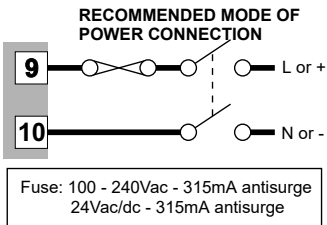
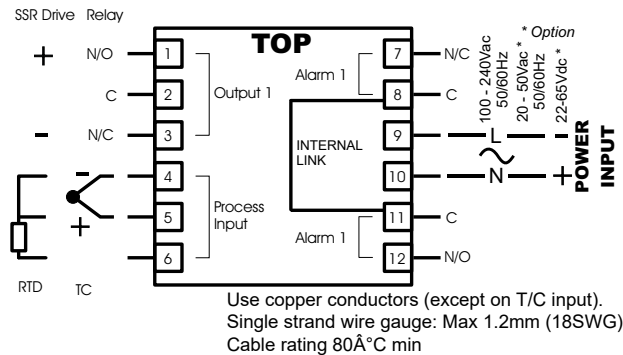

## RANGE/ALARM SELECTION

**CAUTION:** The parameters in this mode must be adjusted only by personnel technically-competent and authorised to do so.

### Entry

Range/Alarm Selection Mode is entered as follows:

1. Press the Scroll and Up keys till the display flashes.
2. When the display starts to flash, release the Scroll and Up keys and press the Down key. The SET indicator will then start to flash and the legend of the first parameter in the sequence (Input Type and Range) will be displayed; 1.5 seconds later the value for that parameter will be displayed.

### Parameter Selection/Adjustment

In this mode, the Scroll key is used to select the required display, as follows:

From previous parameter legend display or entry into Range/Alarm Selection Mode

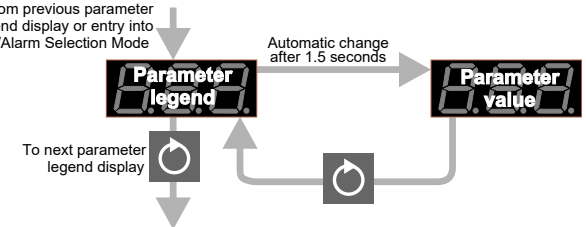

Once the required parameter value is displayed, the Up/Down keys can be used to alter that value; new values are implemented immediately. The parameter sequence is:

Parameter	Displayed Legend	Available Values																																						
Input Type and Range	INP	<table border="1"> <thead> <tr> <th colspan="2">Temperature Units</th> <th colspan="2">Input Range Maximum<sup>1</sup></th> </tr> <tr> <th>Value</th> <th>Units</th> <th>Value</th> <th>Max.</th> </tr> </thead> <tbody> <tr> <td>0</td> <td>°C</td> <td>1</td> <td>500</td> </tr> <tr> <td>1</td> <td>°F</td> <td>2</td> <td>600</td> </tr> <tr> <td></td> <td></td> <td>3</td> <td>700</td> </tr> <tr> <td></td> <td></td> <td>4</td> <td>800</td> </tr> </tbody> </table> <table border="1"> <thead> <tr> <th>Value</th> <th>Input Sensor Type</th> </tr> </thead> <tbody> <tr> <td>1</td> <td>Thermocouple Type J/L</td> </tr> <tr> <td>2</td> <td>Thermocouple Type K</td> </tr> <tr> <td>3</td> <td>Thermocouple Type N</td> </tr> <tr> <td>4</td> <td>Thermocouple Type T<sup>2</sup></td> </tr> <tr> <td>5</td> <td>RTD (-50 to Range Max.)</td> </tr> <tr> <td>6</td> <td>RTD 0.0 to Range Max. - 1 decimal position<sup>1</sup></td> </tr> </tbody> </table> <p>NOTES: 1. The RTD range will always be 0.0 - 99.9 whatever the Range Maximum setting may be.                  2. Absolute Range Max. = 400 °C (700 °F) for TC Type T.</p>	Temperature Units		Input Range Maximum <sup>1</sup>		Value	Units	Value	Max.	0	°C	1	500	1	°F	2	600			3	700			4	800	Value	Input Sensor Type	1	Thermocouple Type J/L	2	Thermocouple Type K	3	Thermocouple Type N	4	Thermocouple Type T <sup>2</sup>	5	RTD (-50 to Range Max.)	6	RTD 0.0 to Range Max. - 1 decimal position <sup>1</sup>
Temperature Units		Input Range Maximum <sup>1</sup>																																						
Value	Units	Value	Max.																																					
0	°C	1	500																																					
1	°F	2	600																																					
		3	700																																					
		4	800																																					
Value	Input Sensor Type																																							
1	Thermocouple Type J/L																																							
2	Thermocouple Type K																																							
3	Thermocouple Type N																																							
4	Thermocouple Type T <sup>2</sup>																																							
5	RTD (-50 to Range Max.)																																							
6	RTD 0.0 to Range Max. - 1 decimal position <sup>1</sup>																																							
Control Action	CTL	<table border="1"> <tbody> <tr> <td>r P</td> <td>Reverse-acting PID control</td> </tr> <tr> <td>d P</td> <td>Direct-acting PID control</td> </tr> <tr> <td>r o</td> <td>Reverse-acting ON/OFF control</td> </tr> <tr> <td>d o</td> <td>Direct-acting ON/OFF control</td> </tr> </tbody> </table>	r P	Reverse-acting PID control	d P	Direct-acting PID control	r o	Reverse-acting ON/OFF control	d o	Direct-acting ON/OFF control																														
r P	Reverse-acting PID control																																							
d P	Direct-acting PID control																																							
r o	Reverse-acting ON/OFF control																																							
d o	Direct-acting ON/OFF control																																							
Alarm Type and Action (available only if an Alarm Option is fitted) NOTE: The operation of the different types of alarm is illustrated overleaf.	AL	<table border="1"> <tbody> <tr> <td>PHd</td> <td>Process High Alarm, direct-acting</td> </tr> <tr> <td>PLd</td> <td>Process Low Alarm, direct-acting</td> </tr> <tr> <td>dEd</td> <td>Deviation Alarm, direct-acting</td> </tr> <tr> <td>bAd</td> <td>Band Alarm, direct-acting Process</td> </tr> <tr> <td>PHr</td> <td>High Alarm, reverse-acting Process</td> </tr> <tr> <td>PLr</td> <td>Low Alarm, reverse-acting</td> </tr> <tr> <td>dEr</td> <td>Deviation Alarm, reverse-acting</td> </tr> <tr> <td>bAr</td> <td>Band Alarm, reverse-acting</td> </tr> </tbody> </table>	PHd	Process High Alarm, direct-acting	PLd	Process Low Alarm, direct-acting	dEd	Deviation Alarm, direct-acting	bAd	Band Alarm, direct-acting Process	PHr	High Alarm, reverse-acting Process	PLr	Low Alarm, reverse-acting	dEr	Deviation Alarm, reverse-acting	bAr	Band Alarm, reverse-acting																						
PHd	Process High Alarm, direct-acting																																							
PLd	Process Low Alarm, direct-acting																																							
dEd	Deviation Alarm, direct-acting																																							
bAd	Band Alarm, direct-acting Process																																							
PHr	High Alarm, reverse-acting Process																																							
PLr	Low Alarm, reverse-acting																																							
dEr	Deviation Alarm, reverse-acting																																							
bAr	Band Alarm, reverse-acting																																							

### Return to Normal Operation

1. Select a parameter legend display.
2. During the 1.5-second legend display, press the Up and Down keys simultaneously for three seconds.

**NOTE:** An automatic return is made to normal operation if there is no key activity in Range/Alarm Selection mode for one minute.

### Default Indication

This display (all decimal points ON) indicates that all Setting Up parameters have been set to their default values (caused by a change to one or more of the critical Range/Alarm Selection parameters). To clear this display, alter one of the Setting Up parameters.

## ALARM OPERATION

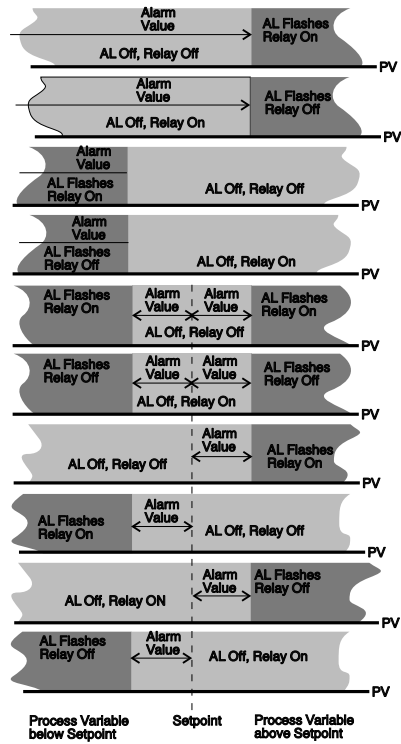

## SPECIFICATION

### UNIVERSAL INPUT

Input Impedance: Greater than 100MΩ resistive,  
Isolation: Isolated from all outputs (except SSR) at 240V AC.

### OUTPUTS

#### Relay

Contact Type/Rating: Single pole double throw (SPDT); 2A resistive at 120/240V AC.  
Lifetime: >500,000 operations at rated voltage/current. Isolated from all other inputs/outputs.

#### SSR Drive/TTL

Drive Capability: SSR = 0 to 10V nominal into 500Ω min.  
Isolation: Not isolated from input. Isolated from Supply and Relay Outputs

### OPERATING CONDITIONS FOR INDOOR USE

Ambient Temperature (Operating): 0°C to 55°C  
Ambient Temperature (Storage): -20°C to 80°C  
Altitude: <2000m  
Relative Humidity: 20% - 95% non-condensing  
Supply Voltage: 100 - 240Vac 50/60Hz (standard) 7.5VA 20 - 50Vac 50/60Hz (option) 7.5VA or 22 - 65Vdc (option) 5W maximum.

### ENVIRONMENTAL

Approvals: CE, UL & cUL  
EMI Susceptibility: Complies with EN61326-1:2013  
EMI Emissions: Complies with EN61326-1:2013.  
Safety Considerations: Complies with UL61010-1 Edition 3.  
Front Panel Sealing: To IP66.

**PHYSICAL**  
Depth: 110mm (behind panel)  
Dimensions Front Panel: Width: 48mm  
Height: 48mm  
Weight: 0.21kg maximum

## Safety and Warning Symbols



Risk of electric shock.



Caution, refer to the manual.



Alternating or direct current could be present.



Equipment protected through-out by double insulation.